



JOCMC37C-M4

Rev.A.1.0

DESCRIPTION:

7KH SURGXFWV DUH SLQ RSWLFDO QHOD\ 7KH GHYLFH F
\$O\*D\$V LQIUUDHG HPSXWLVQVDGHRGSRWLFDOO\ FRXSOHG WR D
KLJK YROWDJH RXWSLXWLQHDVSDVWRWLFFLDZ3 SDFNDJH
7KH GHWHFWRU FRQVLVWV RI D KLJK VSHHG SKRWRYROWDL
DQG GULYHU FLUFXLWUH ZLGH SURGXFWLQJ PHDVXULQJ
DQG WHVWLQJ HTXLSLQDWHVHPSXWLVQVDGHRGSRWLFDOO\
LQGXVWULDO PDFKLQHU\ DQG HTXLSPHQW

MAIN FEATURES

- +LJK LVRODWLQRQ
6LQJOH &KDQQHO 1RUPDOO\ &ORVHG 6LQJOH 3ROH 6LQJOH
2SHUDWLQJ WHPSXWLVQJ WR f&
5(\$&+ 5R+6 FRPSOLDQFH
+%0 + \$ 00 0 &'0 &
&4& DSSURYHG
9'( DSSURYHG
8/ DSSURYHG

ABSOLUTE MAXIMUM RATINGS 7HP SHUDWXUH f&

Table with 4 columns: Parameter, Symbol, Value, Unit. Rows include parameters like )RUZDUG &XUUHQW, 3HDN )RUZDUG &XUUHQW, 5HYHUVH 9ROWDJH, ,QSXW 3RZHU 'LVVLSDWLRQ, /RDG 9ROWDJH, &RQWLQXR XV ORD G FXUUHQW, 2XWSXW 3RZHU 'LVVLSDWLRQ, 7RWDO 3RZHU 'LVVLSDWLRQ, ,VRODWLRQ 9ROWDJH.



NOTE1 111... • %01μ0,1 U OE < μalv Ç

\*

E1

spulsc

ORDERING INFORMATION

- LH-LH - 2 & 0 & &

Characteristics Curves

FIG.1: /(' 'URSRXW 9ROWDJH YV \$ P EFIG.2 WXWSXW &XUUHQW YV 2XWSXV  
7HP SHUDWXUH

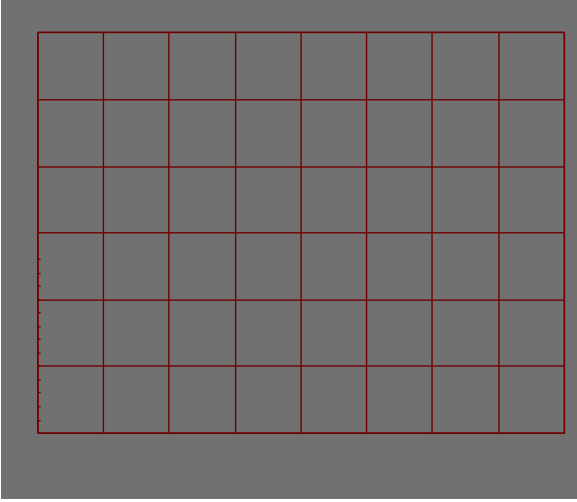

FIG.7: 7XUQ 2Q 7LPH YV \$PELHQW 7HPSHUXDWXUH 7HPSHUXDWXUH

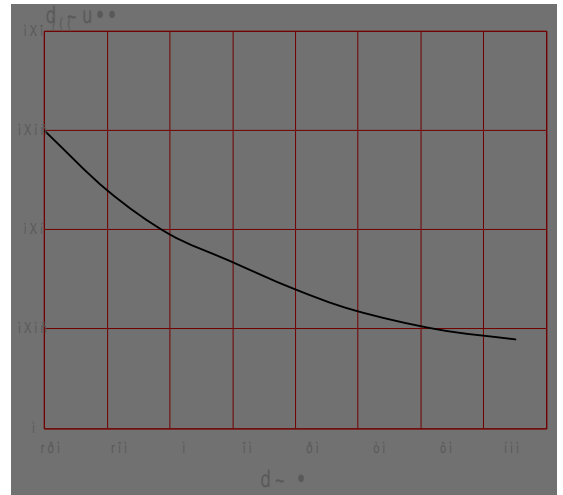
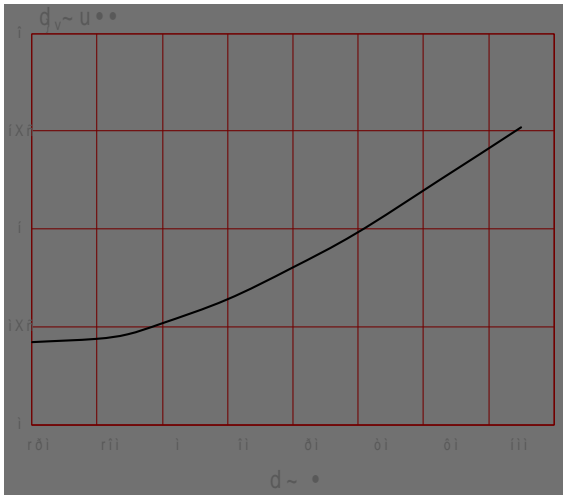

FIG.9: 7XUQ 2Q 7LPH YV /(')RUZDUG 7HPSHUXDWXUH 2II 7LPH YV /(')RUZDUG &XUUHQW

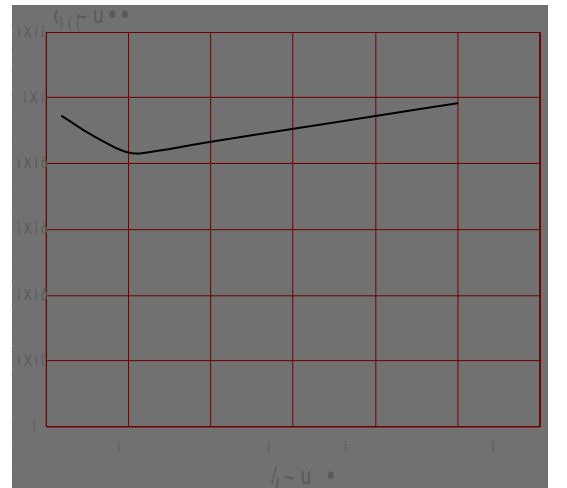
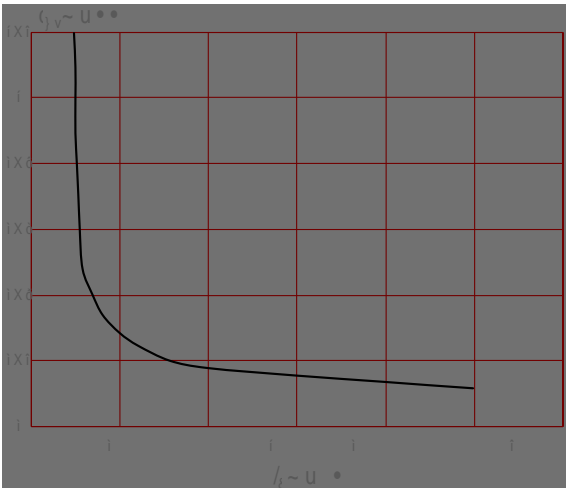
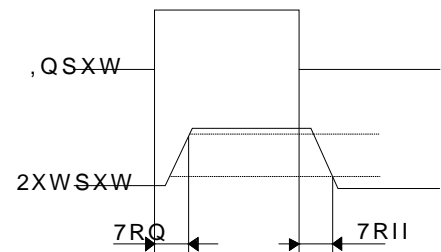
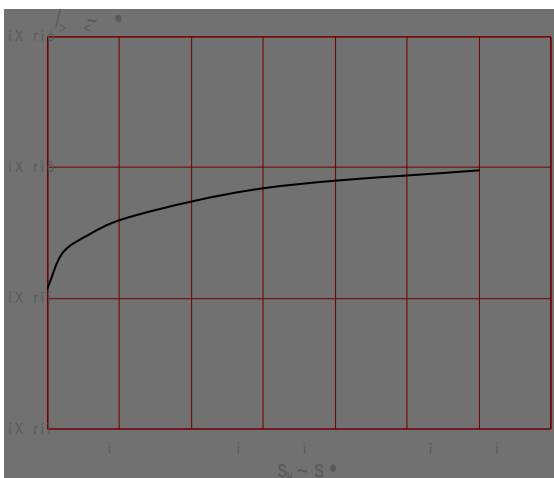
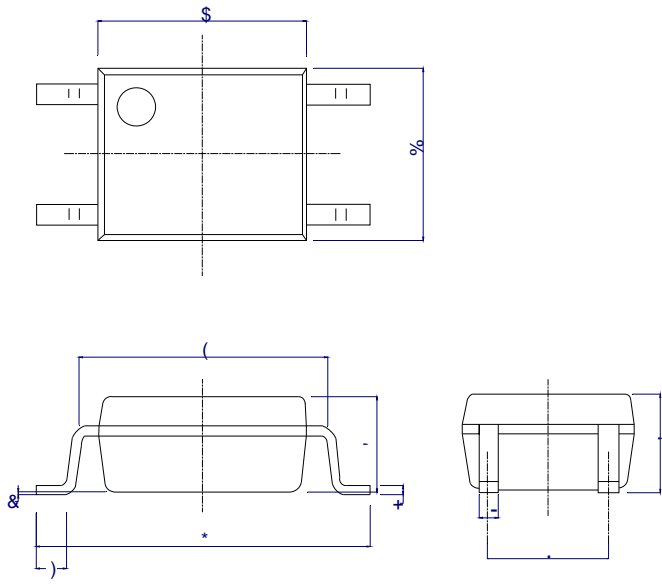

FIG.11: 2II 6WDWH /H DNDWH Y & XURDG 9 FIG.12 Turn on/Turn off time



Package Dimension (Unit: mm)



5HI	'LPHQVLRQV					
	0LOOLPHWHUV			,QFKHV		
	0LQ	7\S	0D[	0LQ	7\S	0D[
\$						
%						
&						
'						
(						
)						
*						
+						
,						
-						
.						

RECOMMENDED SOLDER MASK (Dimensions in mm unless otherwise stated)

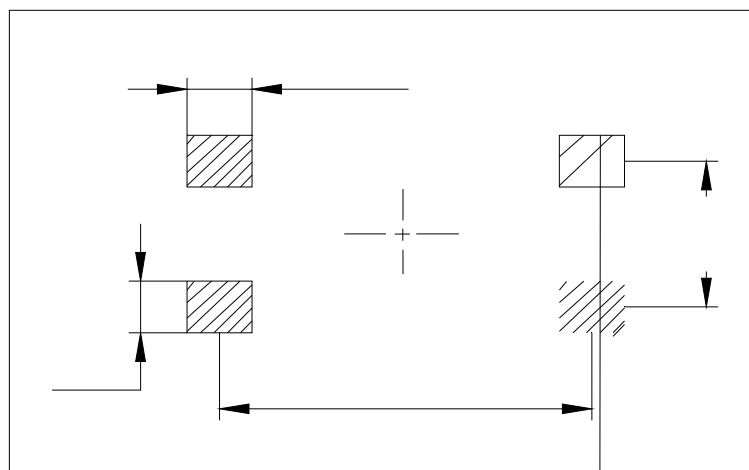

CARRIER TAPE SPECIFICATIONS (Dimensions in mm unless otherwise stated)

Option None

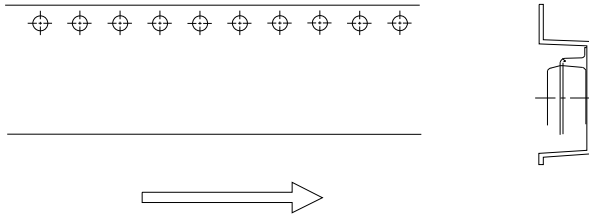

REFLOW INFORMATION

7 HP SHUDMUH

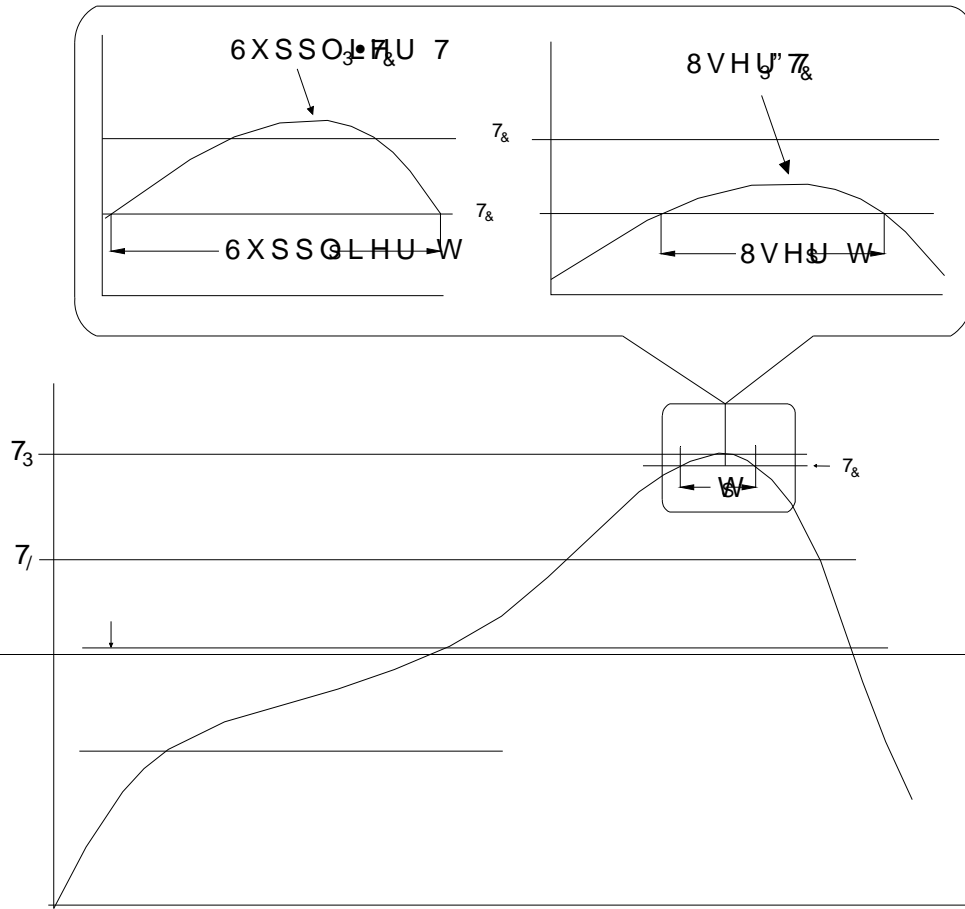



1RWH

5HIORZ VROGHULQJ LV UHFRPPHQGHG DWRVGHQRHPSHHDWKXUHWKDU

\$YRLG GLUHFV FRKWDHFRBEEPRZHQQWXRUDFRUVH[FHHGLQJLWV PD  
VWRUDJH WHPSHUDWXUH

\$SSOLFDWLRQ RIIHSUSIRVXELURKQZWSOHGDDWHG WHPSHUDWXUHV ,QV  
VFHQDULRV DQHPSVOLHQRWRHFFHHG 1

(QVXUH WKH FRPSRQHQW KDV FRROHG SMRRDIRHGHKQWZVHPSHUTXMXQ  
PDQXIDFWXULQJ VWHSV

7KH FRPSRQHQW KH BV DQVKHDIUOZKHQVWDQGHGKFRQGLWLRQV

5HFRPPHQG VWRUDJH 7HPS a f&

5HFRPPHQG VWRUDJH KXPLGLW\

06/ OHYHO 06/

,QIRUPDWLRQ IXUQXFKHQ/ LQ WKOLHGRHFG WR EH DFFXUDWH D  
-LDQJVVX -LH-LH 0LRRHOWHGFWDVROLFFVQLRVUHRUSRQVHLERQVHT  
RI XVH ZLWKRXW FRQVLGHUDWLRQ IRG MWFKQIQURPDPDWLRQ  
LQ WKLV GRFXPHQFKLQJYXZLWHKFRXWRQRWLFH DSDUW IURP V  
VLJQHGH -LDQJVVXOLHIVLZILFRKPKKH DJUHHPHQW

3URGXFWV DQG LQIRUPDWLRQ SURYLGHG LQ HQWVVRG RSDXPH  
-LDQJVVX -LH-LH DVVXIPHLVQW\URVSRQVLQIULQJHPPHQW RI RW  
ZKLFK PD\ UHVXOW IURP WKH XVH RI VFKLW SURFXPHQW DQGS HL  
DQG UHSODFHV DOO LQIRUPDWLRQ SUHYLRXVO\ VXSSOLHG



LV D UHJLVWHUHGDQJJDGHLPHUN RUF-URHOWHFWURQLFV & R  
&RS\ULJKW -LDQJVVX -LH-LH FLV & R HOWHFGV SPODLHG LJKWV UHVH