

- 67 8 6 : \$ 7 5 , \$ &

5HY \$

^ Z / W d / KEW

7KH -67 8 6: W X L W F D E O H V I R U J H Q H U D O S X U S R V H
\$ & V Z L W F K L Q J , W F D Q E H X V H G D V D Q 2 1 2)) I X Q F W L R Q L Q
D S S O L F D W L R Q V V H F X O D W K R Q W L Q G X F W L R Q P R W R U
V W D U W L Q J F L U F R Q W W V R I O R U S H K U D D W L R Q L Q O L J K W
G L P P H U V P R W R U V S H H G F R Q W U R O O H U V - 6 7 8 6 :
V Q X E E H U O H V V W O O D E H L F R H P P S I O F L H G I R U X V H R Q
L Q G X F W L Y H O R D G H Q G W L F H D Q W E H V K U R X J K W K H 0 & 8 , 2
S R U W & R P S O \ L Q Q Q D W G V 8 /) V W H U H I (
3 D F N D J H 7 2 L V 5 R + 6 F R P S O L D Q W

D / E & dhZ ^

^ K > h d D y / D h D Z d / E ' ^

3 D U D P H W H U	6 \ P E R O	9 D O X H	
6 W R U D J H M X S F W L R Q U W H P D Q J H V W J		7	
2 S H U D W L Q J W H F O S H U L D R O X U H	U D Q M H	7	
5 H S H W L W L Y H S H D N R M I V W D W H 5 0 R O W D J H		7	9
5 H S H W L W L Y H S H D N W H Y H U V H 9 5 5 R O W D J H		7	9
5 0 6 R Q V W D W H & F X U U H Q W 7	, 7 5 0 6		
1 R Q U H S H W L W L Y H V X U J H S H D N R Q V W D W H F X U U H Q W			
IXOO F s \ F O H M W			\$
1 R Q U H S H W L W L Y H V X U J H S H D N R Q V W D W H F X U U H Q W	7 6 0		
IXOO F s \ F O H P V W 7			
, W Y D O X H I R U P X V L Q J W	, W		\$ V

8 Q L V

& U L W L F D O B D W G R W D W H F X U U H Q W
; h , * 7 l +] M 7 G , G < ð , 0 " 1 ' ñ D # g 8 , l @ € • H ! g x P H

-67 8 6:

-LH-LH 0LFURHOHFWURQL

3HDN JDWH SRZHU	3*0		
3HDN SXOVH YROWDJH 7M QRQ UHSHWLWLYH RII	9SS VWDWH), *		

:
NE

> dZ/ > , Z d Z^d/ XQOHVV RWKHUZLVH VSHFLILHG

8\PERO	7HVW &RQGLWLRQ	4XDGUDQW	9DOXH
--------	----------------	----------	-------

-67 8 6:

-LH-LH 0LFURHOHFWURQL

KZ Z/E' /E&KZD d/KE

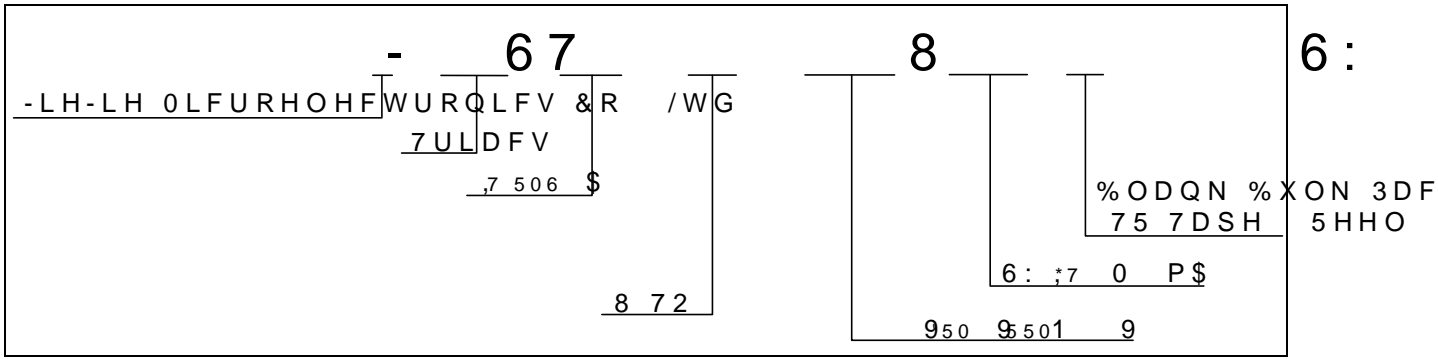

D Z</E'

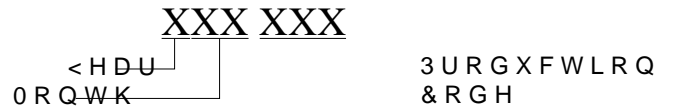
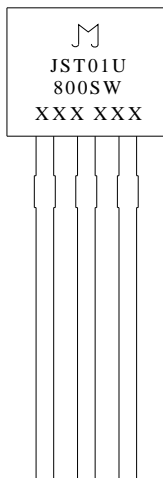

- 67 8

),* 0D[LP
RQ VWDW

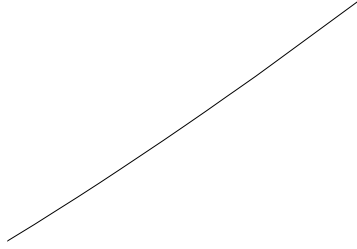

iXö iXö iXö í íXí

), * Ö7HVW FLUFXLW IRU LQGXFWLYH DQG VMDQGDUGV OR

, (& 6WDQGDUGV
6XUJH *HQHUDWRU
6YROWDJH VXUJH
6FXUUHQW VXUJH

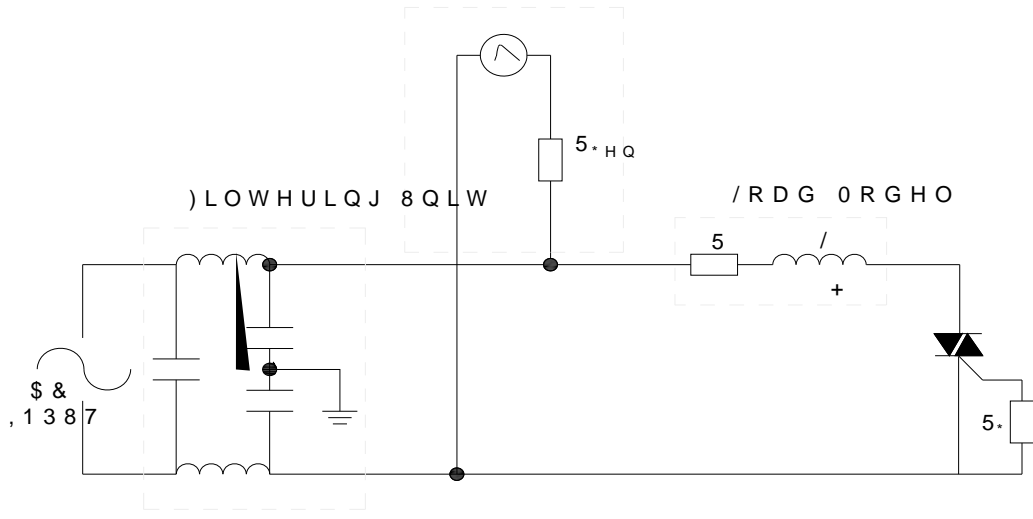

)LOWHULQJ 8QLW

/RDG 0RGHO

KZ Z/E' /E&KZD d/KE

2UGHU FRG	9ROWD 9 ₅₀ 9 ₅₀ 9	,*7 P\$	3DFNDJH	%DVH SFV	'HOLYHU\ PRGH
-67 8 6:			72		%XON 3DFN
-67 8 6: 75					7DSH 5HHO

'RFXPHQW 5HYLVLRQ +LVWRU\
'

'DWH	5HYLVLRQ	&KDQJHV
\$SU	\$	/DVW XSGDWHG
ODU	\$	5HQH\$&.\$*(0(&+\$1,&\$/ '\$7\$
6HSW	\$	5HYLVLRQ\$&.\$*(0(&+\$1,&\$/ '\$7\$

W < ' D , E/ > d

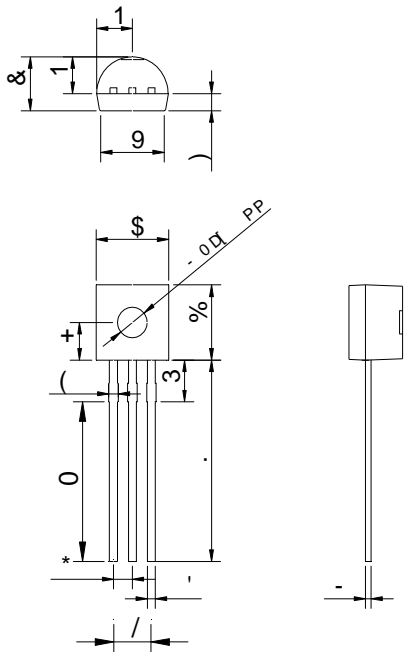

5HI	'LPHQVLRQV					
	0LOOLPHWHUV , QFKHV					
	0LQ	7\S	0D[0LQ	7\S	0D[
\$						
%						
&						
'						
(
)						
*						
+						
-						
.						
/						
0						
1						
3						
9						

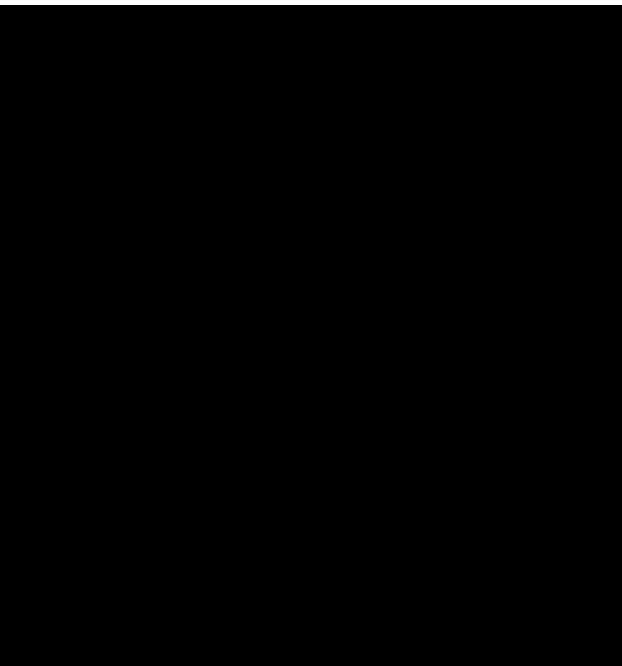

	%\$* 3&6	,11(5 %2; 3&6	&\$5721 %2; 3&6
3DFN			

'LPHQVLRQV

5HI 0LOOLPHWHUV ,QFKHV
 0LQ 7\ S OD[0LQ 7\ S OD[
 3
 3 s ^
 3 G
 3
 , 3
) A)
))
 :
 :
 :
 :
 , +
 /
 +

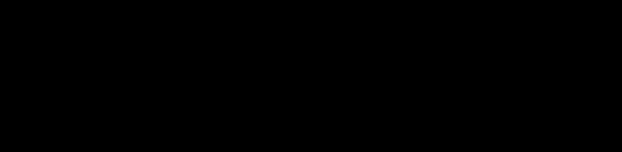

,QIRUPDWLRQ IXUQXPHQW ILQ WKOLHGRHG WR EH DFFXUDWH
 -LDQJVX -LH-LH 0LRRHOWHG WDVROLFHV OLWU HRUS ROKH ERQVH
 RI XVH ZLWKRXW FRQVLGHUDWLRQ IRG MWFKQIRUPDWRORQ
 PHQWLRQH G LQ WKXVGRFXPHQW KDVQ JB SZLWK RXPQRKDLW HZ
 DJUHHPHQW LV VLJQLHGFREDSQLWX -ZLHWK WKH DJUHHPHQW