

($T_j=25$ unless otherwise specified)

Symbol	Test Condition	Quadrant	Value		Unit
I_{GT}	$V_D=12V$ $R_L=33$	- -	MAX.	5	mA
				10	
V_{GT}		ALL	MAX.	1.3	V
V_{GD}	$V_D=V_{DRM}$ $T_j=125$ $R_L=3.3k$	ALL	MIN.	0.2	V
I_L	$I_G=1.2I_{GT}$	- -	MAX.	10	mA
				20	
I_H	$I_T=50mA$		MAX.	7	mA
dV/dt	$V_D=400V$ Gate Open $T_j=110$		MIN.	80	V/ μs
$(dV/dt)_c$	$(dI/dt)_c=0.3A/ms$, $T_j=110$		MIN.	5	V/ μs
t_{on}	$I_G=20mA$ $I_A=200mA$ $I_R=20mA$ $T_j=25$		TYP.	2.5	μs
t_{off}				25	

Symbol	Parameter		Value(MAX.)	Unit
V_{TM}	$I_{TM}=1A$ $t_p=380\mu s$	$T_j=25$	1.5	V
V_{TO}	Threshold voltage	$T_j=125$	1.01	V
R_D	Dynamic resistance	$T_j=125$	316	m
I_{DRM}	$V_D=V_{DRM}$ $V_R=V_{RRM}$	$T_j=25$	5	μA
I_{RRM}		$T_j=125$	0.2	mA

Symbol	Parameter	Value	Unit
$R_{th(j-c)}$	junction to case (AC)	25	μW
$R_{th(j-a)}$	junction to ambient (AC)	120	μW

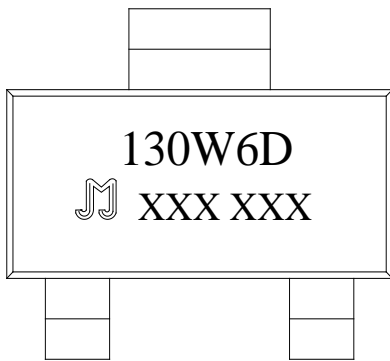
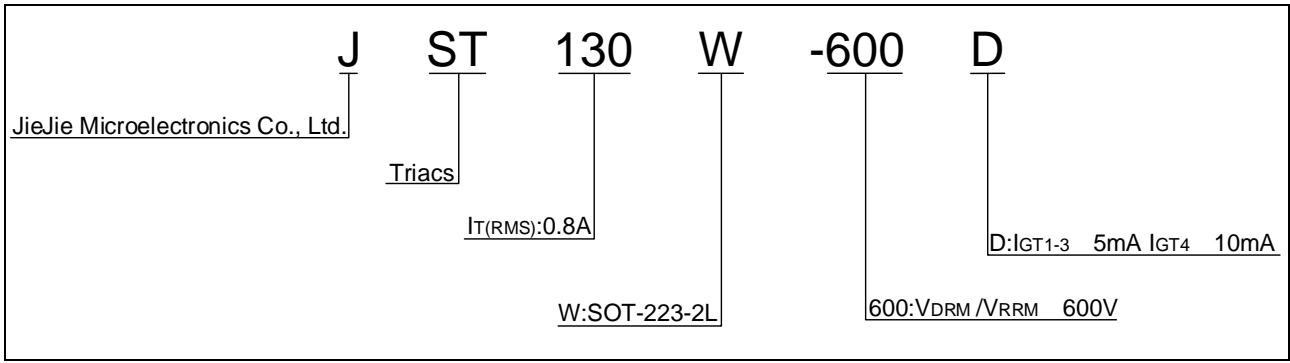

XXX XXX

LOT NO.

FIG.1: Maximum power dissipation versus RMS on-state current

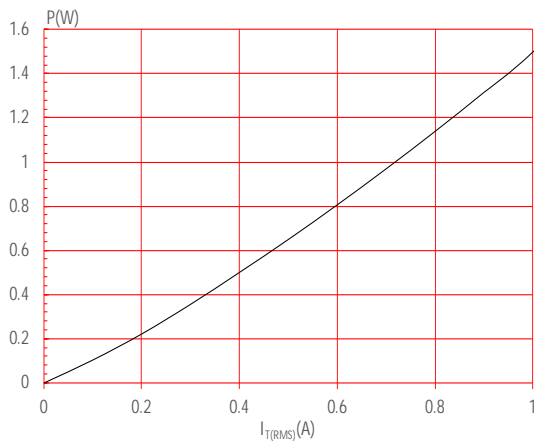

FIG.2: RMS on-state current versus case temperature

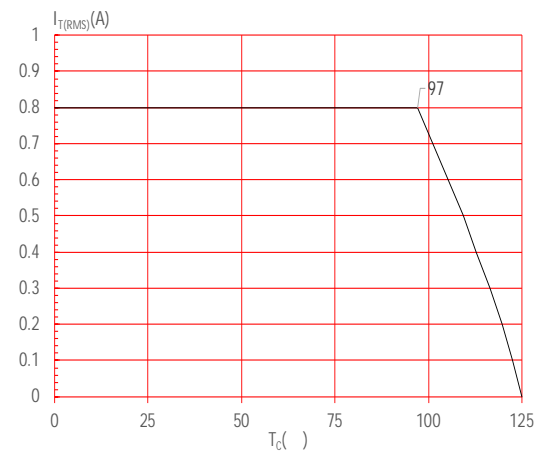

FIG.3: RMS on-state current versus ambient temperature (printed circuit board FR4, copper thickness: 35 μ m) (full cycle)

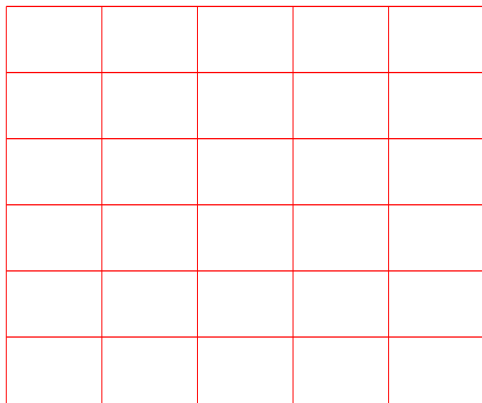

FIG.4: Surge peak on-state current versus number of cycles

FIG.7: Relative variations of gate trigger current, holding current and latching current versus junction temperature

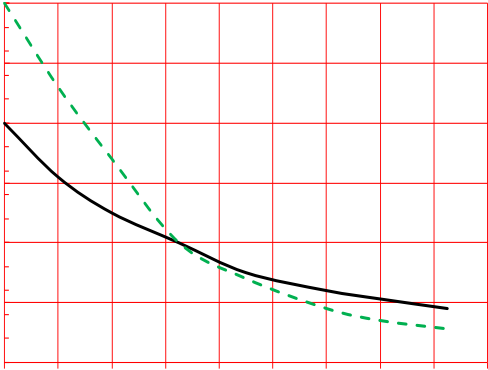
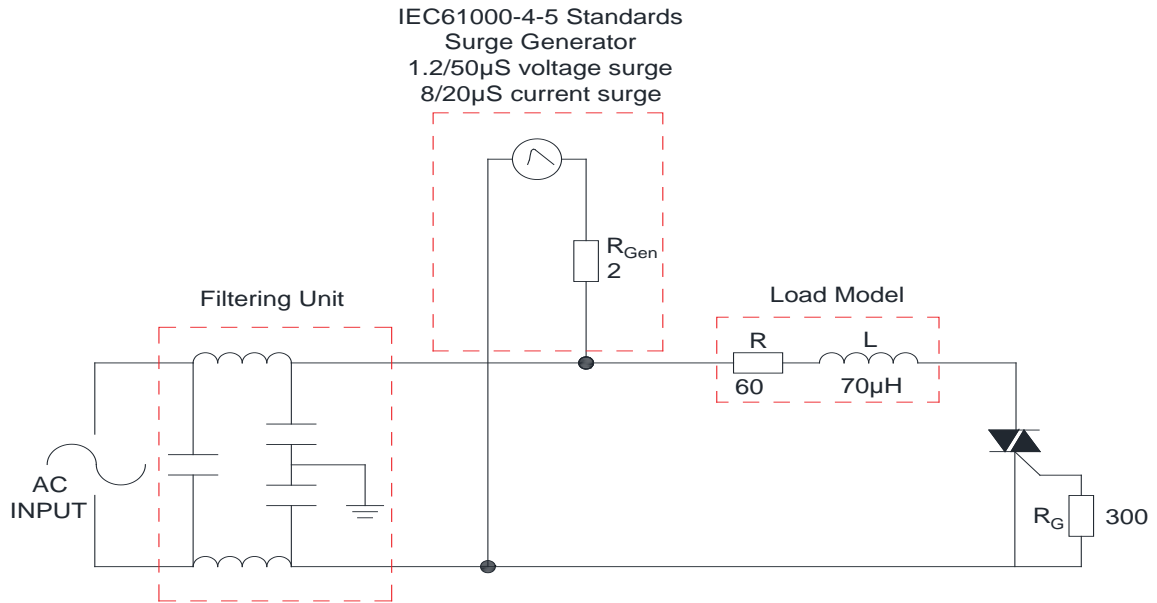
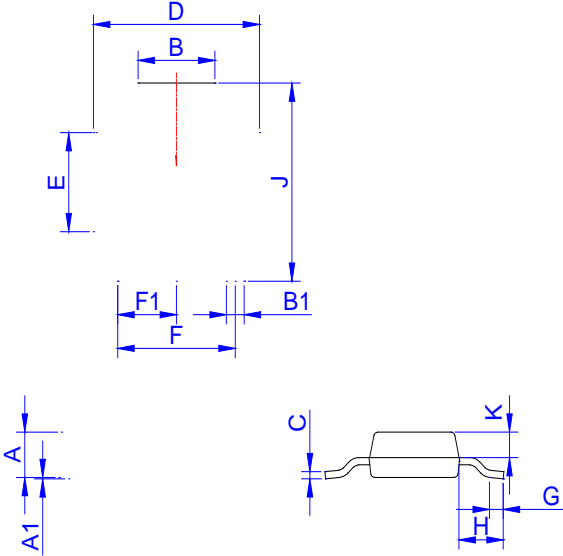

FIG.8 Test circuit for inductive and resistive loads to IEC-61000-4-5 standards



Order code	Voltage V_{DRM}/V_{RRM} (V)	IGT(mA)		Package	Base qty. (pcs)	Delivery mode
		-	-			
JST130W-600D	600	5	10	SOT-2235	0/ST	



Ref.	Dimensions					
	Millimeters			Inches		
	Min.	Typ.	Max.	Min.	Typ.	Max.
W	-		12.30	-		0.482
E	1.65	1.75	1.85	0.065	0.069	0.073
F	5.45	5.50	5.55	0.215	0.217	0.219
D0		1.55	1.60		0.061	0.063
D1		-	-			
P0	3.90	4.00	4.10	0.154	0.157	0.161
P1	7.90	8.00	8.10	0.311	0.315	0.319
P2	1.95	2.00	2.05	0.077	0.079	0.081
10P0	39.80	40.00	40.20	1.567	1.575	1.583
A0	6.85	6.95	7.05	0.269	0.273	0.276
B0	7.15	7.25	7.35	0.280	0.284	0.288
K0	1.95	2.05	2.15	0.076	0.080	0.084
T	0.20	0.25	0.30	0.008	0.010	0.012

Information furnished in this document is believed to be accurate and reliable. However,